



**MICROFLEX LR**  
**ULTRASONIC LEVEL**  
**TRANSMITTERS**

# MULTI-DROP CAPABILITY

Up to 32 Microflex LR transmitters can be used on a Multipoint Comms network utilising Modbus or Vision System II software. This offers significant cable savings and can be expanded to a maximum of 256 instruments on a single pair of wires.

Typical applications for this are on tank farms, screen houses and water treatment plants etc.

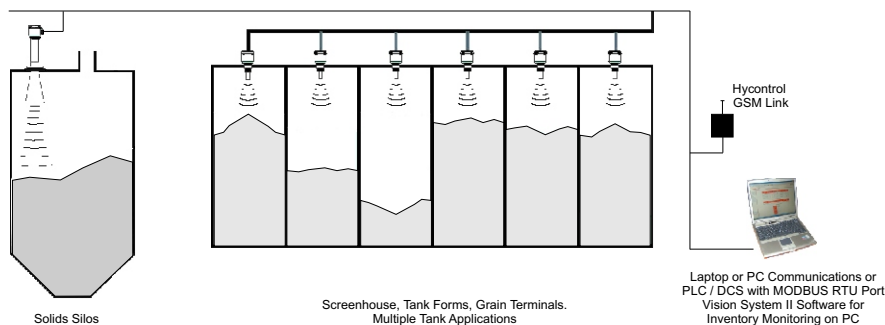

# REMOTE COMMISSIONING & FAULT DIAGNOSIS

## Vision System II Remote Communications and Commissioning Software.

Vision System II is a powerful software package which enables remote programming, multi-drop facility and silo monitoring in the same package.

Microflex LR has been designed to make the commissioning of more difficult applications less complex by building in remote access capability via the Hycontrol GSM Link (HGSML). With this option Hycontrol engineers can dial into the GSM Link connected to Microflex LR from Vision System II software anywhere in the world. Once connected, the Microflex LR can be programmed, commissioned and monitored from the comfort of your own office.

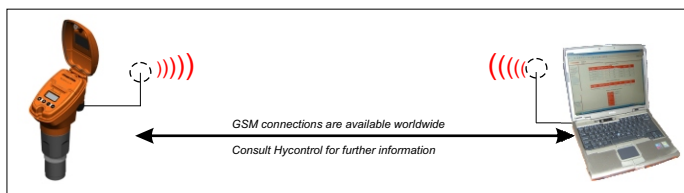

Using the Modbus option with Vision System II, up to a maximum of 256 instruments can be connected on a single loop. Each one of these levels can be displayed in multiples of nine per display screen on the Vision System II software.

# LOW POWER APPLICATIONS

Many applications in remote areas do not have a power supply available but critical level measurement data is required. This is often supplied from either batteries or solar power, but both of these options require very low power consumption to make a practical and viable solution with regard to size and cost.

Hycontrol has developed in the MICROFLEX LR MS, one of the lowest power level measuring devices available which consumes, at full power, less than two milliamps.

For applications such as combined sewer overflows (CSO) or remote river monitoring this is an essential requirement. For this application a Microflex LR MS is used with a special pre-programmed algorithm to reduce power to a minimum but still maintain accurate level measurement. The output from this device is a Modbus output which is usually input to another ancillary device such as a datalogger, telemetry unit or plc system.



Low power, remote river level monitoring

# APPLICATIONS FOR ALL INDUSTRIES



QUARRY

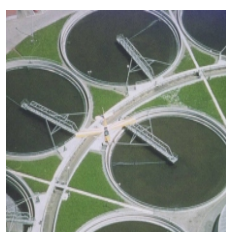

WATER & WASTE

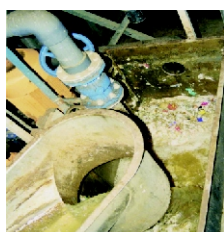

PROCESS



CHEMICAL



OFFSHORE

# NON-CONTACT ULTRASONIC LEVEL TRANSMITTERS



MICROFLEX LR

Microflex LR pushes the boundaries of non-contact ultrasonic level measurement. This new range of Smart Level Transmitters is capable of measuring distances in excess of 60 metres and is suitable for solids and liquids.

Using new technology developed with low frequencies these new transmitters are capable of measuring in extremely difficult applications, including very dusty and dirty environments, where most traditional ultrasonics will fail. Level measurement on difficult solids applications in excess of 60m is now possible with two wire technology.

The Microflex LR is available in two configurations with two wire technology; an Integral display (MI) four-button programmable instrument and a SMART blind (MS) version.

This new range can be programmed remotely using Hycontrol's Vision System II software and using this option instruments can be connected, via the link, to a Hycontrol Service Engineer in our UK office to analyse and overcome any commissioning issues which may be experienced in the field, without having to actually visit site and incur any additional call-out charges.

## MICROFLEX LR

### MICROFLEX LR MI

The Microflex LR MI transmitter with display is available with four different acoustic frequencies capable of reliably tracking the level of solid and liquid products under extreme conditions. It is easily programmed via a four button keypad and an integral menu driven display to simplify commissioning.

The Microflex LR MI with display is available as a two wire loop powered instrument or, alternatively, as a three or four wire 80-260vac or 24vdc version. Optional relay outputs are also available on the ac versions if required.

Hazardous areas for dust and gases pose no threat to this new series of transmitters with ATEX options of EExia IIAT4 and ExII 1 D T85.

### MICROFLEX LR MS

The Microflex LR MS smart instrument without display is programmable either by MODBUS or Vision System II software. The smart devices have the capability to run on a 9-24vdc power supply, have one relay output option, plus a special option to run on low power if required.

## MICROFLEX LR ADVANTAGES

- ◆ Non-contact ultrasonic technology with no moving parts
- ◆ Versatile technology for liquids, slurries, solids, pellets and powders
- ◆ Long measuring range up to 60m with two wire technology
- ◆ Advanced echo extraction to avoid spurious signals and avoid dust issues
- ◆ Wide range of outputs including HART, analogue, serial comms, Modbus
- ◆ Remote connectivity for programming and commissioning via GSM link software
- ◆ Wide range of supply voltages including 2, 3 and 4 wire configurations
- ◆ Hazardous area approved for gases and dusts
- ◆ Chemically resistant transducer range for flexibility on applications
- ◆ Simple setup via PC Software or integral push button
- ◆ Separate electrical terminal compartment for better isolation risk
- ◆ Wide range of flange options and process connections
- ◆ Ultra low power options with 12vdc supply
- ◆ Unaffected by dielectric constant properties

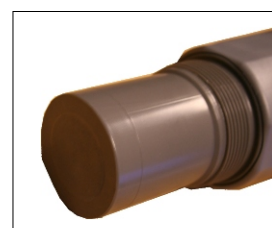

Chemical Resistant



Remote interrogation



Simple push button setup



SMART 'blind' Transmitter



Multiple electrical entries

# SPECIFICATION

<b>Instrument Type</b>	: <b>Microflex LR (MI)</b>	<b>Microflex LR (MS)</b>
	: 2 wire powered or 2,3,4 wired ac/dc	2 wire loop powered or 3 wire dc
<b>Range</b>	: Up to 60 metres	Up to 60 metres
<b>Blanking</b>	: Variable from 0.3 metres	Variable from 0.3 metres
<b>Process media</b>	: Liquids or Solids	Liquids or Solids
<b>Analogue Output</b>	: 4-20mA into 750 Ohm	4-20mA into 750 Ohm
<b>Power Supply</b>	: 12 - 30 v dc	10 - 25 v dc
	: 90 - 256v ac	
<b>Relays</b>	: 2 Form C SPDT rated 5 amp at 240v ac	1 Form C SPDT on 3 wire version only
<b>Resolution</b>	: 1mm up to 20 metre range	1mm up to 20 metre range
	: 4mm from 20-60 metre range	4mm from 20-60 metre range
<b>Accuracy</b>	: +/- 0.25% of maximum range	+/- 0.25% of maximum range
<b>Operating temperature</b>	: -40°C to + 80°C	-40°C to + 80°C
<b>Ambient temperature</b>	: Electronics -40°C to + 80°C	Electronics -40°C to + 80°C
<b>Display</b>	: 2 line 8 digit LCD	Not applicable
<b>Enclosure</b>	: Integral System IP67	Sealed IP68
<b>Key Pad</b>	: Integral 4 button	Not applicable
<b>Mounting</b>	: 2" NPT or BSP or Flanged ANSI DIN or JIS	2" NPT or BSP or Flanged ANSI DIN or JIS
<b>Weight</b>	: 2kg - 15kg depending on transducer power	2kg - 15kg depending on transducer power
<b>Cable Entries</b>	: 3 x M16 Cable Glands	
<b>Max.System Pressure</b>	: 2 bar	2 bar
<b>Comms</b>	: Modbus / HART	Modbus
	: GSM/CDMA connectable	GSM/CDMA connectable
	: Vision System II	Vision System II
	: Hycontrol GSM Link	Hycontrol GSM Link
	: Multi-drop capability (up to 32 units)	Multi-drop capability (up to 32 units)
<b>Certification</b>	: ATEX EExia	ATEX EExm

# MICROFLEX LR DIMENSIONS

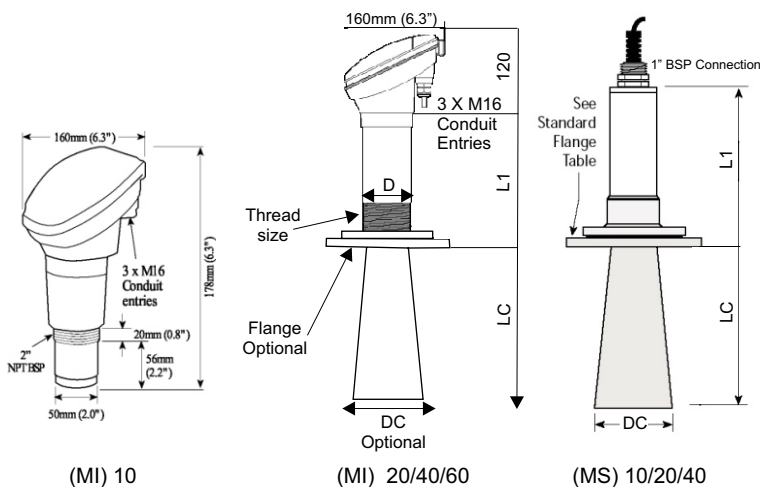

Integral Transmitter (MI)

Range Metres	L1	LC Optional	D	DC Optional	Thread Size	Flange Optional
10	140	-	50	-	2"	-
20	185	258	75	98	3"	4"
40	360	413	89	263	3.5"	10"
60	672	413	89	263	-	10"

Blind Transmitter (MS)

Range Metres	L1	LC Optional	D	DC Optional	Thread Size	Flange Optional
10	185	-	50	-	2"	-
20	208	258	75	98	3"	4"
40	537	413	89	263	3.5"	10"

Flange Options: ANSI, DIN or JIS



# HYCONTROL LEVEL TECHNOLOGIES

## Product Range For Solids :-

- (1) TDR Radar For Solids
- (2) Ultrasonic, 'Through Air'
- (2) 2 Wire Ultrasonic Transmitter
- (3) FMCW 2 Wire Radar
- (4) Continuous 'Servo' Level Indicator
- (5) FMCW 2 Wire Radar
- (6) Capacitance Level Switch
- (7) Vibrating Probe Level Switch
- (8) Rotating Paddle Level switch
- (9) Microwave Level Switch
- (10) Doppler Flow Switch

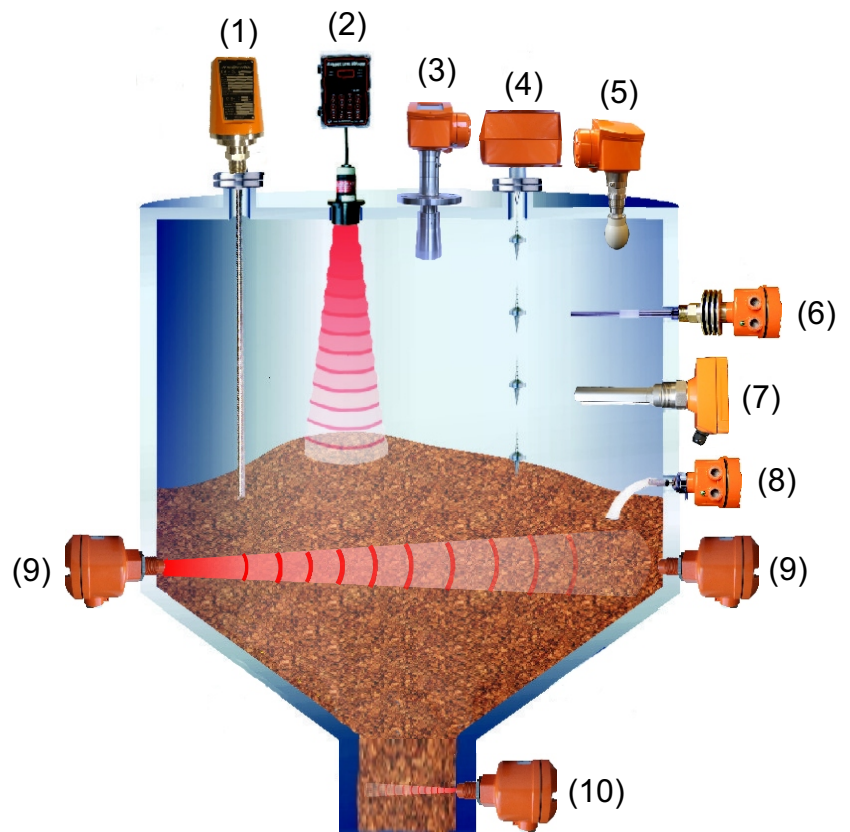

## Product Range For Liquids :-

- (1) By-Pass Level Indicator With Radar
- (2) TDR Radar For Liquids
- (3) 2 Wire Ultrasonic Transmitter
- (4) FMCW 'Horn' Radar 2 Wire
- (5) Magnetic Float Switches
- (6) FMCW 2 Wire Radar
- (7) Capacitance Level Switch
- (8) RF Admittance Level Switch
- (9) Side Mounting 316 SS Float Switch
- (10) Tuning Fork Level Switch
- (11) Tuning Fork Level Switch
- (12) Ultrasonics 'Through Wall'
- (13) Mini Magnetic Float Level Switch

